

# Banquette - request form

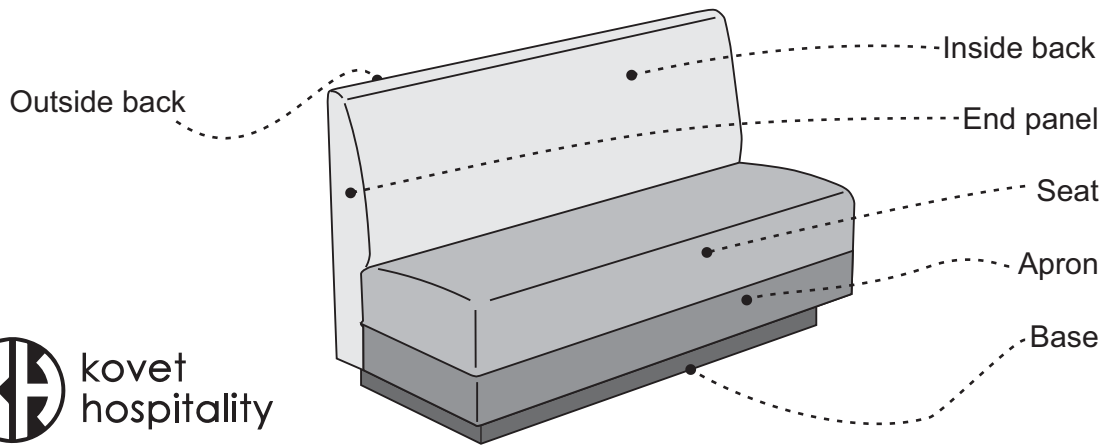

## Required project information for quote (all fields bellow must be filled)

Quote due date: \_\_\_\_\_

Request install date: \_\_\_\_\_

Zip code for freight cost: \_\_\_\_\_

## Dimensions

OAW: \_\_\_\_\_ OSH: \_\_\_\_\_

OAH: \_\_\_\_\_ OAD: \_\_\_\_\_

OAD: \_\_\_\_\_ SD: \_\_\_\_\_

## Style guide / finish materials (Required to quote)

Back style:	Back fabric:	Wood finish:
End panels style:	Seat fabric:	Metal finish:
Seat style:	Apron material:	Leather material:
Apron style:	Base material:	
Base / leg seat: <input type="checkbox"/> Custom	Wood species:	<input type="radio"/> Beech <input type="radio"/> Maple <input type="radio"/> Oak <input type="radio"/> Alder <input type="radio"/> Walnut <input type="radio"/> Red Oak <input type="radio"/> White Oak <input type="radio"/> Mahogany <input type="radio"/> Teak <input type="radio"/> Iroko <input type="radio"/> Ash

## Configurations (Required to quote)

<input type="checkbox"/> Single	<input type="checkbox"/> Straight	<input type="checkbox"/> Ellipse
<input type="checkbox"/> Double	<input type="checkbox"/> L-shape	<input type="checkbox"/> Zig zag
<input type="checkbox"/> U-shape	<input type="checkbox"/> Rotunda	<input type="checkbox"/> 3/4 Circle
<input type="checkbox"/> 1/4 Circle	<input type="checkbox"/> Custom Curve	<input type="checkbox"/> Stone Casegood

**Number of sections:** \_\_\_\_\_

**Electrical:**  
 Cubiepod  Cubiemod  Furnlite  Other   
 Cord Length:

## Banquette - styles

Inside back

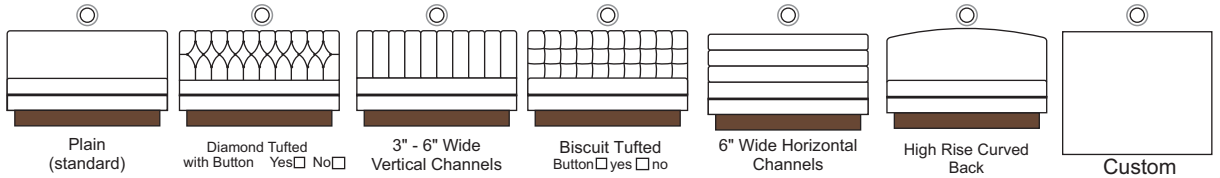

Base

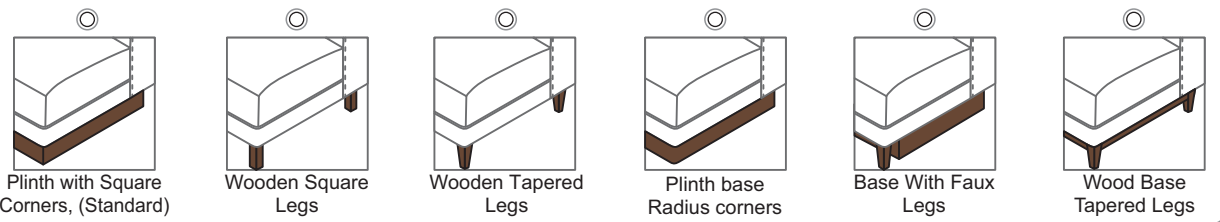

Seat edge

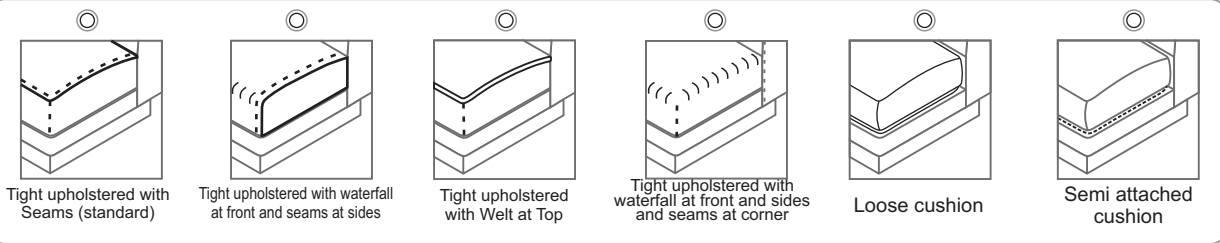

End panel

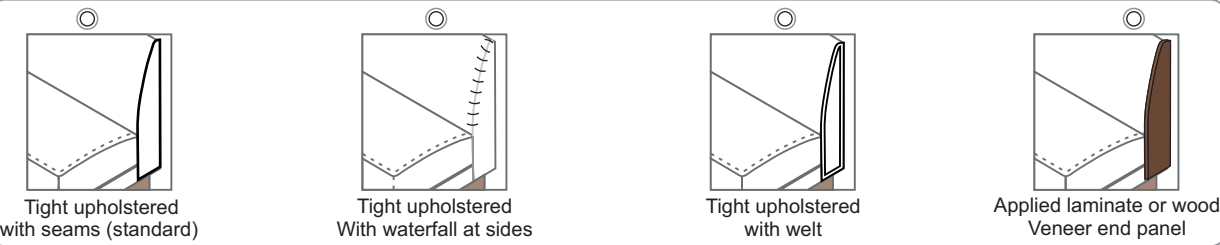

Seat Construction

- Webbing
- Hand-Tied Springs
- Solid Board with Venting Holes

- Use:
- Dining
  - Lounge
  - Custom

### Seam Stitch

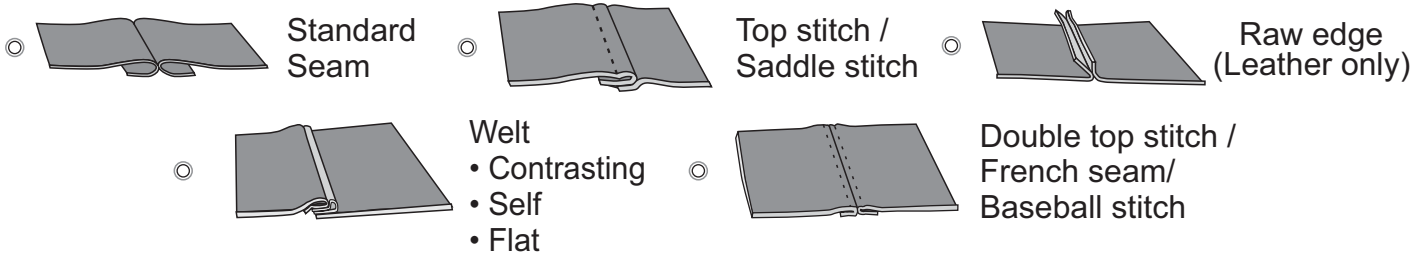

### Outside back

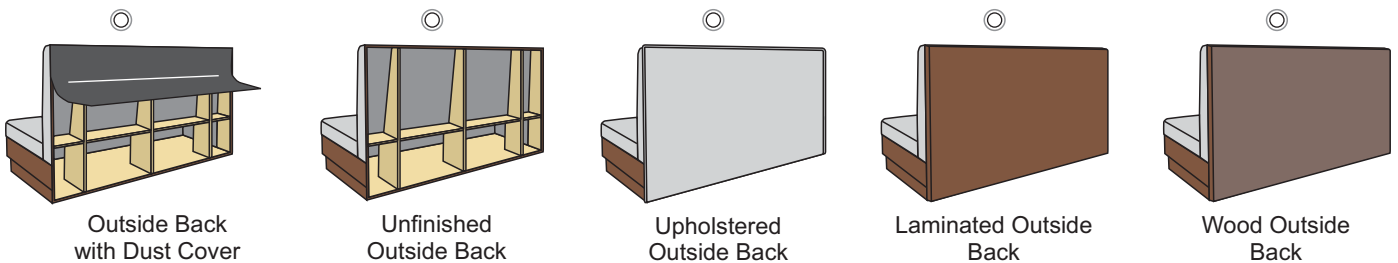

\* Kovet does not offer V. I. F.

\* Space fillers and Stone Tops provided by others.